



BAEHREN PHOTO CO.
206 HURON ST.
TOLEDO, OHIO

argus C-44



the new companionable **argus C44**

The new Argus C44, with its built-in convenience and versatility, is America's finest 35mm camera and the perfect companion for every picture-taking assignment.

The following pages describe the steps in picture-taking with the C44. Reading these instructions will assure complete success with your very first roll of film.

Because Argus products are constantly being improved, minor changes in appearance of the product may not be included in this instruction book. A letter or card addressed: SALES SERVICE DIVISION, ARGUS CAMERAS, ANN ARBOR, MICHIGAN, will bring answers to questions about the use of your C44 camera or other Argus equipment.



CONTENTS:

Functional Parts.....	3, 4
Loading.....	5-7
Color-matic Settings.....	8
Shutter, Aperture Settings.....	9, 10
Focusing, Holding Camera.....	11
Depth of Field.....	12
Color Exposure Guide.....	13-14
Black & White Exposure Guide... ..	15-16
Flash Photography.....	17-20
Interchangeable Lenses.....	21-26

functional parts

To help you become familiar with your C44 Camera, the functional parts are indicated here for easy reference. Familiarity with these names before loading and operating the camera will help you become acquainted with it easily.

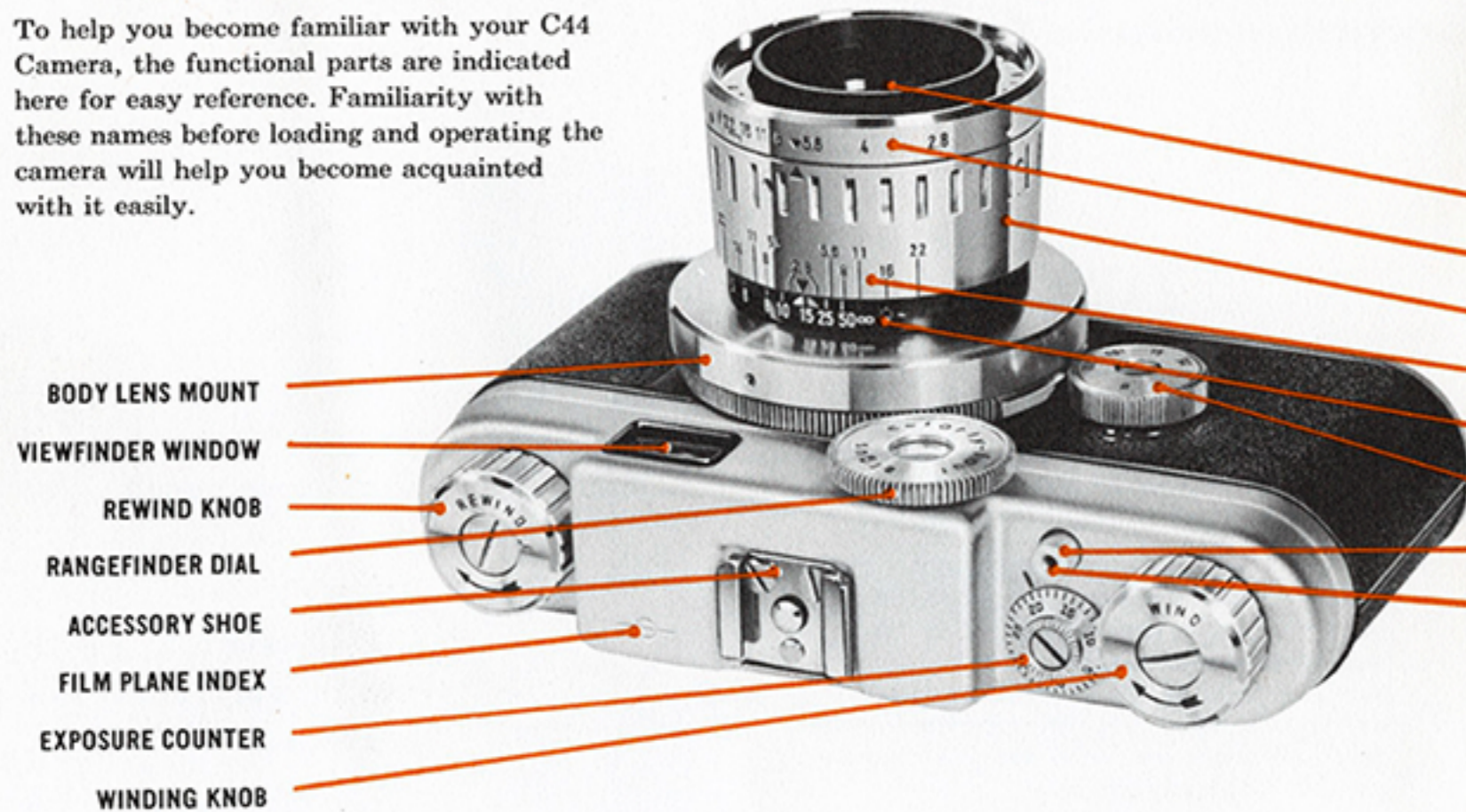

FLASH SYNCHRONIZATION SELECTOR

VIEW AND RANGEFINDER

TAKE-UP SPOOL

ROLLER

SPROCKET

FILM COMPARTMENT

FILTER RETAINER

APERTURE RING

LENS BARREL

DEPTH OF FIELD SCALE

DISTANCE SCALE

SHUTTER SPEED DIAL

SHUTTER RELEASE

CABLE RELEASE SOCKET

LENS LOCK RELEASE

LOCKING DEVICE

TRIPOD SOCKET

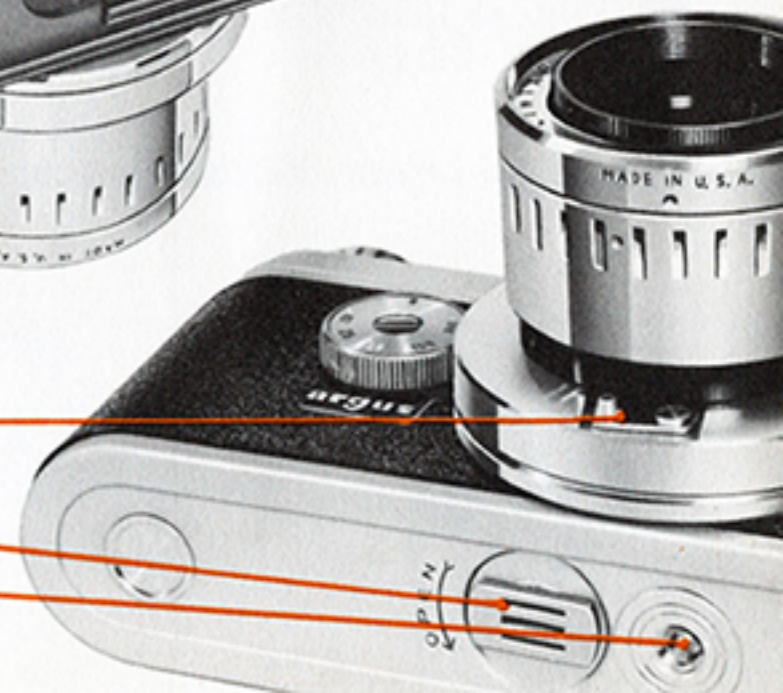
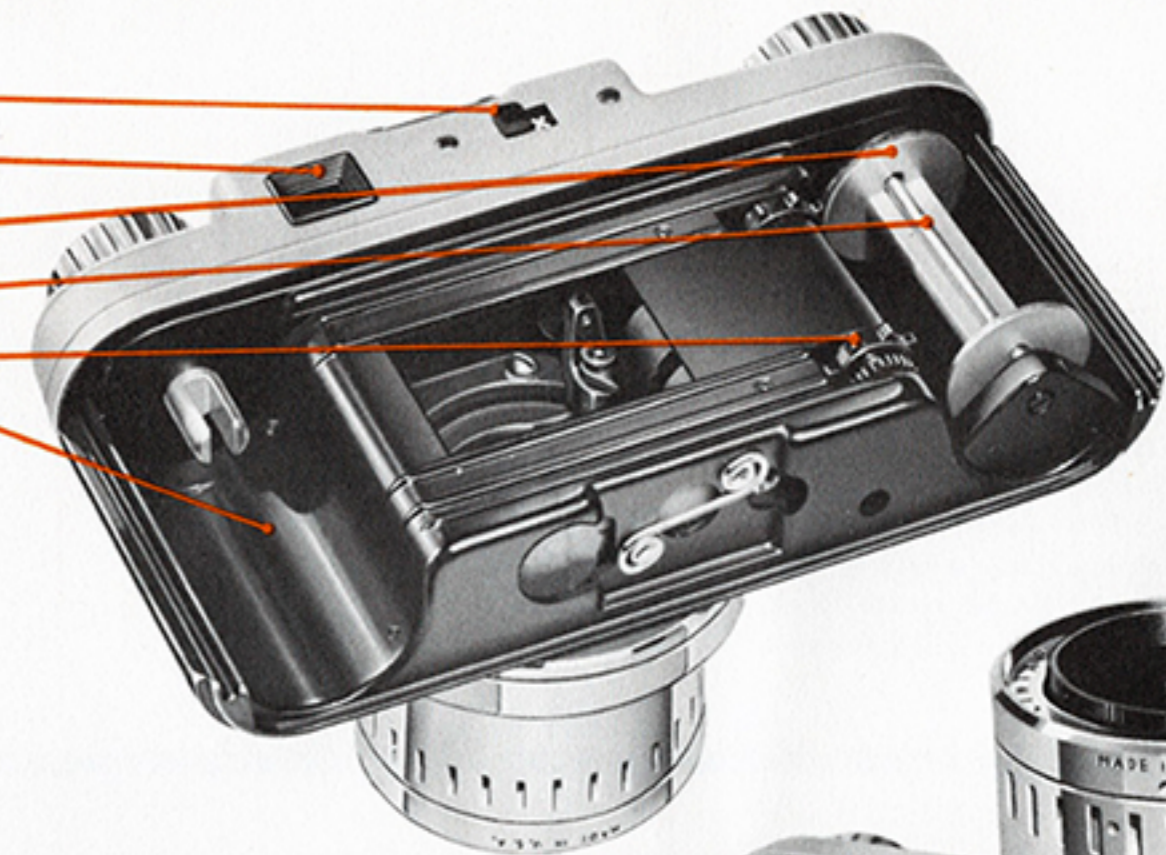

loading

1

Remove camera from case by unsnapping front flap and loosening screw on bottom. Remove camera back by turning locking device in "open" direction and sliding back off.

2

Turn the wind knob until it stops, then rotate the take-up spool with your thumb so that the flat surface of the spool and the small roller are facing up, as in illustration.

3

Place a cartridge of fresh 35mm film in the film compartment, turning the rewind knob if necessary so that cartridge seats properly (up against top of compartment).

4

Thread film so that three perforations of film are under small roller, as in illustration. Perforations should be engaged on sprocket, which is connected to exposure counter.

5

Press shutter release and turn wind knob about half a turn until end of film folds back against itself, as in illustration. Be sure film remains engaged on sprocket "teeth."

6

Place back against camera with sides engaged in grooves. Slide back up into closed position, turning locking device in direction opposite to arrow to lock back tightly closed.

DO YOU PLAN TO TAKE A TRIP? Or photograph some special event? If so, you should expose a practice roll or two of film, including some flash pictures. This will acquaint you with your new camera and prevent the disappointment of spoiling an important picture through lack of familiarity.



5

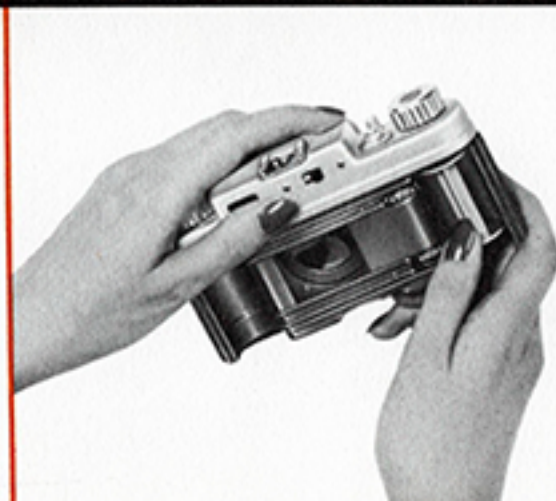

6

7

Turn wind knob until it stops, press shutter release, and again turn wind knob until it stops. These two winds take up film leader and advance fresh film into position. Winding film also cocks the shutter, preventing double exposure. Since shutter will be cocked each time film is wound, be careful not to press shutter release before you are ready to take your first picture.

8

The exposure counter dial must be set each time you reload. After fresh film has been advanced into position, press counter dial down and turn to 20 (for a 20 exposure roll) or to 0 (for a 36 exposure roll). The dial makes a complete revolution each time you wind the film, and automatically stops at the mark indicating the number of exposures remaining on the film.

unloading

When end of film is reached, film must be rewound back into film cartridge. Pull wind knob completely up and rotate it $\frac{1}{4}$ turn backwards. Using rewind knob, rewind film until counter dial has stopped rotating. Continue to turn knob a few extra revolutions to be sure film is entirely in cartridge. Open back, remove film cartridge, and have film developed as soon as possible.

color-matic settings

While the C44 is a truly versatile camera, capable of meeting every photographic need, it can also be used like the simplest camera. For outdoor snapshots just set it on "Color-matic," then wind film and snap the shutter for each picture without any further adjustments. It's so simple, anyone in the family can take beautiful pictures with the C44.

Color-matic markings on aperture ring, distance scale and shutter speed dial provide "universal" settings for average subjects in bright sunlight and sharp focus for these subjects between 9 and 50 feet.

Yellow markings are used with Kodachrome Daylight film (ASA 10).

Red markings are used with Ektachrome or Anscochrome Daylight Color Films and with Plus-X, Supreme or similar black and white films (ASA 32-80).

SHUTTER SPEED DIAL



APERTURE RING



DISTANCE SCALE

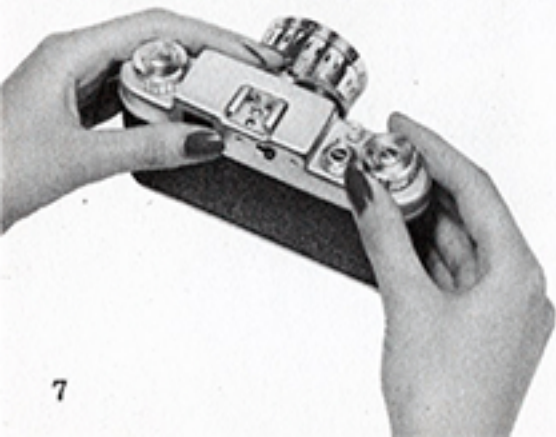

shutter speed and aperture settings

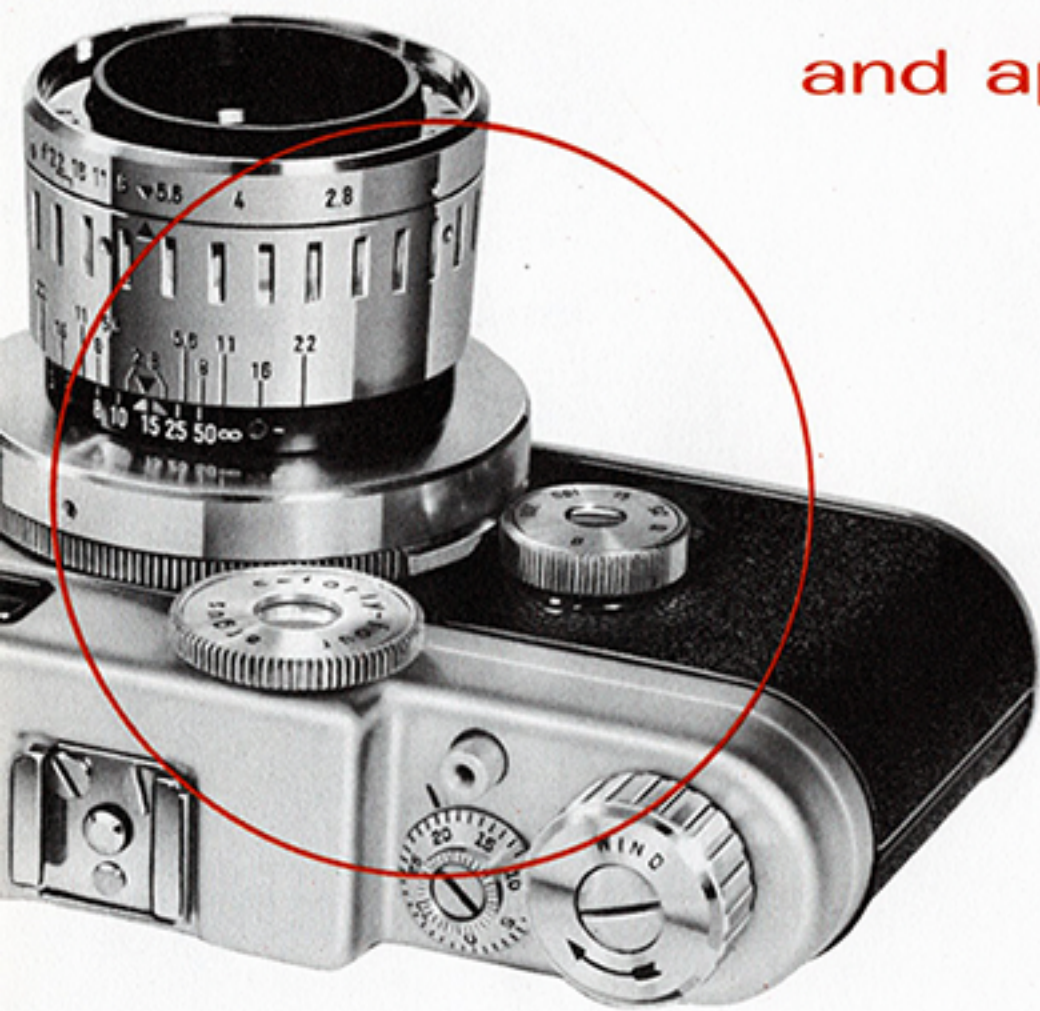

The C44 Camera features a quick-action control center where aperture, shutter speed, focus, winding and shutter release controls are conveniently grouped for easy and rapid adjustment.

You will want to adjust shutter speed and aperture settings according to the "speed" of your film, the amount of light available and the kind of subject you are "shooting."

The right combination of shutter speed and aperture setting will give you a properly exposed negative or color transparency with a suitable range of sharp focus and freedom from subject movement. The best exposure is usually a compromise; if movement has to be stopped, a fast shutter speed is most important, but if a deep zone of sharp focus is essential, a small aperture should be used.

APERTURE

The amount of light passing through the lens while the shutter is open is controlled by the aperture setting (f:stop). In the Argus C44, you have a wide choice of settings, ranging from the smallest opening, f:22, to the largest opening, f:2.8. Each f:stop admits twice as much light as the preceding one. For example, f:5.6 admits twice as much light as f:8. The triangular pointer between f:5.6 and f:8 on the aperture ring indicates f:6.3, an intermediate or half-stop setting. The aperture ring of your C44 "clicks" into position at each marked setting. However, it may also be set at any intermediate position.

To set aperture, rotate aperture ring until desired f:number is directly opposite index pointer on lens barrel.

The aperture also controls the range of sharp focus in your pictures. Small apertures (e.g. f:22) give a deep zone of sharp focus, while large apertures (e.g. f:2.8) give a shallow zone of sharp focus (see page 12).

SHUTTER

The length of time the shutter is open to admit light when you press the shutter release is controlled by the shutter speed dial. Numbers on the dial indicate fractions of a second and are selected by rotating the dial to bring the desired number directly over the index dot when looking from the top of the camera. **ALWAYS SET THE SHUTTER SPEED DIAL DIRECTLY ON THE NUMBER.** Areas in between do not provide accurate intermediate speeds.

When the dial is set at "B", the shutter will remain open as long as the shutter release is held down, permitting time exposures. To avoid movement when making longer exposures, the camera should be on a tripod or other steady support and a cable release used to operate the shutter.

To "stop" movement broadside to the camera, use the fastest shutter speed and try swinging your camera with the subject. (It is easier to "stop" subject action moving directly toward or away from the camera.)



OUT OF FOCUS



IN FOCUS

focusing

The precision, superimposed image-type rangefinder in your Argus C44 is coupled directly and permanently to the lens mount. The combined rangefinder-viewfinder allows you to compose your picture and focus through the same eyepiece. You automatically focus the lens for sharp pictures by turning the rangefinder dial until the double image in the small circular spot becomes a single image.

The camera may be held in either a horizontal or vertical position to best suit composition in your picture. Either position permits the shutter to be released with a firm, smooth motion of the finger, preventing camera movement. When using the viewfinder, keep in sight all four sides of the viewfinder window to avoid "cutting off" important parts of the picture.

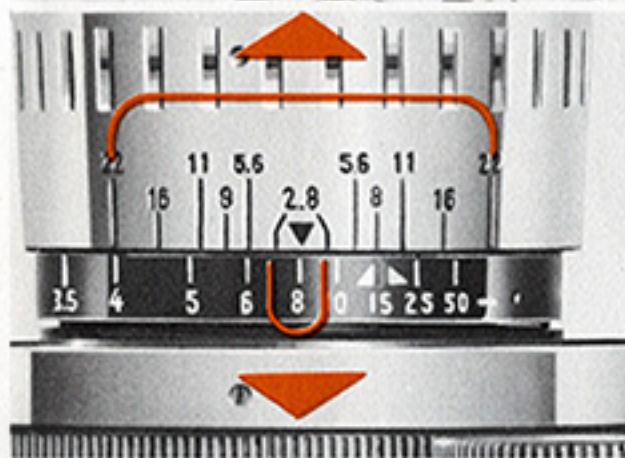

depth of field

The aperture setting not only controls the amount of light that reaches the film, but also determines "depth of field," which is the range of sharp focus in front of and beyond the subject focused upon.

The illustrations on this page show you the difference in range of sharp focus when the smallest and largest apertures are used at the same distance settings. The camera in the illustration is focused on 8 feet. By reading between identical f: numbers on the depth of field scale, you see that if f:22 is used, the range of sharpness extends from 4 feet to infinity. When f:2.8 is used, everything from 7 to 9 feet is in focus.

By turning the rangefinder dial you can watch the depth of field for any one aperture change as the distance scale changes. Consulting the handy depth of field scale helps find the best combination of aperture and distance setting.

beautiful color transparencies

Sunlight shining directly on the picture subject from behind the photographer is generally the best lighting for outdoor color pictures . . . and the best time of day is mid-morning or mid-afternoon. The lower angle of morning or afternoon sun enhances scenic shots with longer dramatic shadows. Directly overhead, the sun causes shadows to be uninteresting and very black. They can be troublesome when shooting pictures of people.

Pictures taken in the shade with the proper warm-toned filter are often pleasing, and here flash can be used to supplement available light. The use of an ultraviolet (haze) filter is recommended in mountains or at the beach, but never use a filter designed for black-and-white film with color film.

The exposure guide on page 14 will help you to select the correct aperture and shutter settings for *average* outdoor picture subjects (nearby people, gardens, houses, light and dark objects in about equal proportions). Close lens one stop from chart setting for *light subjects* (distant scenery, marine, beach and snow scenes, light color objects dominating). Open lens one stop more for *dark subjects*, people in dark clothing, dark foliage, flowers, animals and buildings.

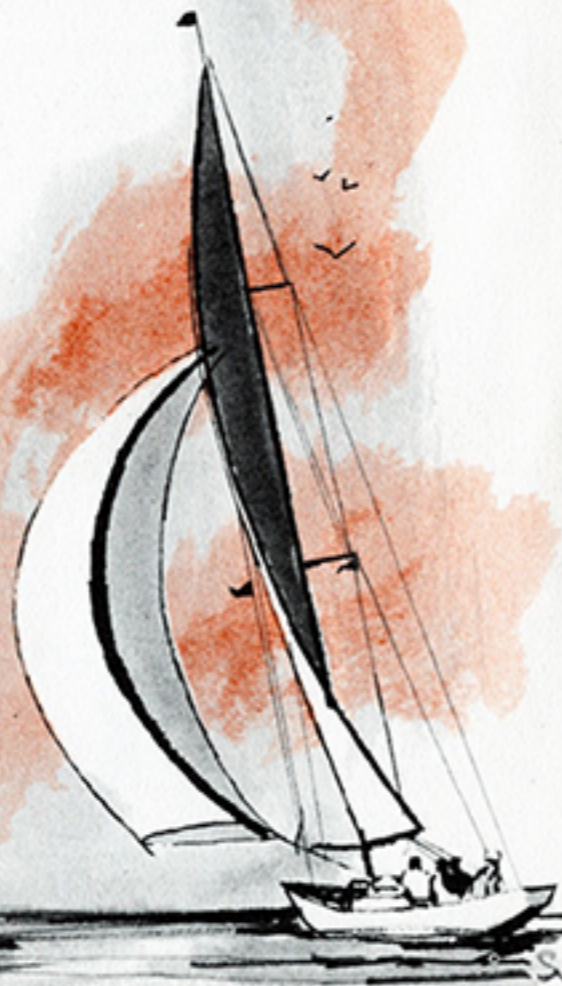

A light-colored subject against a dark background always makes an effective shot.



Scenic shots like this one make excellent subjects for color slides.



Use a blue flashbulb to lighten the shadow side of a back-lighted subject.

OUTDOOR EXPOSURE GUIDE FOR COLOR FILM
with average subjects. Use shutter speed shown in first column.

FILM	Shutter Speed	Bright Sun	Hazy Sun	Cloudy Bright	Cloudy Dull
Ektachrome Daylight Anscochrome Daylight	100	f:8	f:5.6	f:4	f:2.8
Ektachrome Type F* Anscochrome Flash Type* (with filter*)	100	between 5.6 & 8	between 4 & 5.6	between 2.8 & 4	**
Kodachrome Daylight (or indoor type with filter*)	50	between 5.6 & 8	between 4 & 5.6	between 2.8 & 4	**

*BSC-type correction filters must be used with indoor type color films exposed in daylight. Consult manufacturer's instructions.

**Use "CLOUDY BRIGHT" aperture setting and the next slower shutter speed setting.

black and white photos

Modern black and white film, coupled with the fine lenses of your Argus C44, will produce perfect photographic results, but checking composition before snapping the shutter always results in pictures of more dramatic interest. Try framing the scene with some nearby foreground, and include people when you can to add human interest. Watch for that unusual angle from which to shoot the picture, or try a close-up using a neutral background to place emphasis on your picture subject.

Pictures taken indoors with existing light are very lifelike, and modern fast films make these a "cinch". Outdoors, filters will dramatize clouds and can also be used to brighten foliage or produce moonlight effects.

Action always adds interest to any photo, and the easiest way to stop action is to shoot it "head on". When you "pose" individuals or groups, give them something natural to do and have your camera pre-set so you can snap the pictures quickly.

You needn't be afraid to experiment with the rules. Shoot scenes that interest you at any time of day or night . . . the new films can take it, and you'll be excited with the results!



Use filters for dramatic cloud effects

Shoot "head-on" to stop action



Frame your picture for a feeling of depth

OUTDOOR EXPOSURE GUIDE FOR BLACK AND WHITE with average subjects. Use shutter speed shown in first column.

FILM	Shutter Speed	Bright Sun	Hazy Sun	Cloudy Bright	Cloudy Dull
Kodak Tri-X	100	f:22	f:16	f:11	f:8
Ansco Ultra Speed Pan Kodak Plus-X	100	f:16	f:11	f:8	f:5.6
Ansco Supreme	100	f:11	f:8	f:5.6	f:4
Kodak Panatomic-X	50	f:11	f:8	f:5.6	f:4

Open the lens one stop more for dark subjects; close the lens one stop for light subjects. When using filters, or if subject is shaded from the sun, larger apertures must be used. Always consult instructions packed with your film or filters.

attaching flash gun

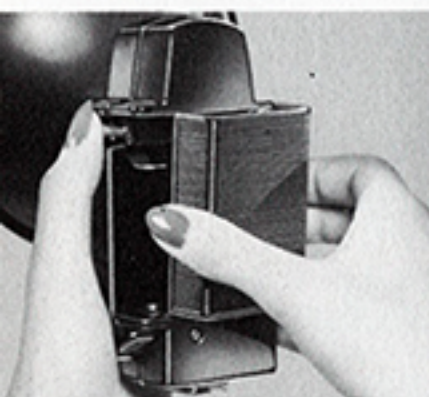

1
The Argus C44 flash unit is designed to accommodate two size "C" photoflash batteries or a B-C power unit. To install batteries, remove the back of the battery case by grasping it at the sides and pulling directly outward.



2
When inserting batteries, be sure to position the left-hand cell top-up and the right-hand cell top-down. Photoflash batteries should be replaced after four months' use or as soon as 50 to 60 flash exposures have been made.

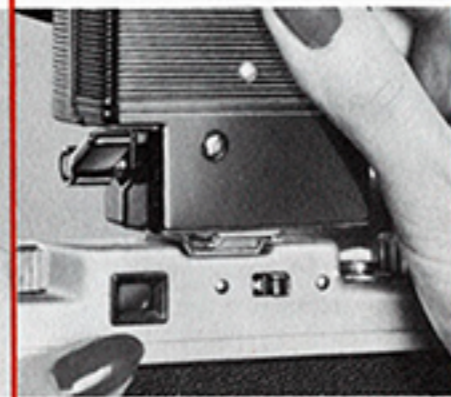

3
Be sure flash unit does not have a flash lamp in it before attaching unit to camera. Turn locking lever on base of unit upward and slide bottom flanges of flash unit forward into the camera accessory shoe as far as they will go.

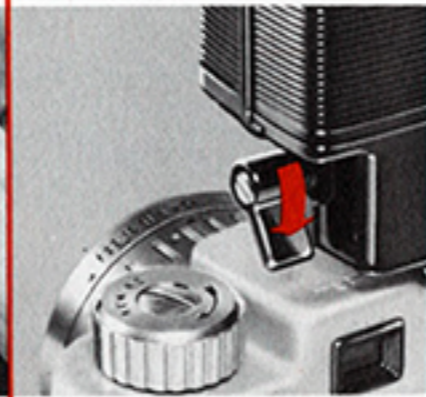

4
Lock flash unit on camera by pressing down firmly on the locking lever. Check unit occasionally while making flash pictures to make sure lock is tight. Perfect electrical contact is made through elements in mounting device.



5
The side-to-side movement of the flash synchronization selector to "M" (20 millisecond delay) or "X" (zero delay) permits use of several types of flash equipment at various shutter speeds. (Consult Guide on page 20).



6
Any Sylvania midget-base flash lamp may be used. Align studs on base of lamp with slots in reflector socket and push lamp in as far as it will go while supporting battery case with other hand. Do not turn lamp after insertion.

continued



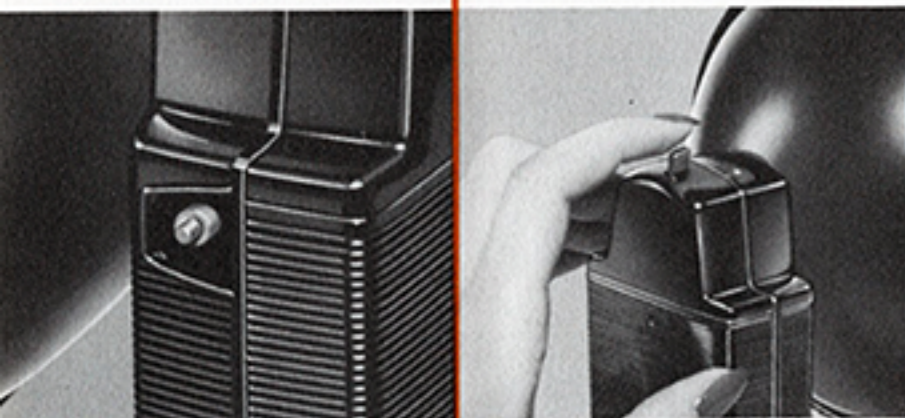

pointers on flash photography

Flash pictures with the new Argus C44 are easy, sure and excitingly lifelike. Flash "brings the sunlight indoors," permitting pictures anywhere, anytime, regardless of existing light conditions.

Family activities make wonderful flash pictures. You will treasure shots of evening activities, parties and holiday dinners. Outdoors, flash eliminates dark shadows under the eyes, nose and chin . . . shadows that ruin so many wonderful snapshots. Flash permits color pictures on cloudy days and assures you a good picture every time!

Flash lamps occasionally shatter, and to avoid any possible danger, a shield of translucent material may be used over the flash reflector. Never use flash in an explosive atmosphere.

7

A bayonet terminal is provided for multiple flash extension when using a B-C unit. Ordinary batteries are not powerful enough for this "in-series" connection.

8

Immediately after making a flash exposure the lamp will be HOT. Eject lamp without touching it by pressing down on the red ejector button at top of battery case.

flash exposure guide

Guide numbers are given in the chart below for combinations of popular films and flash lamps. By dividing the guide number by the number of feet between your camera and subject, you obtain the correct aperture setting (f:stop). Guide numbers are intended as guides to correct exposure and may be changed to suit individual requirements.

EXAMPLE: For Ektachrome Type F and Press 25 flash lamp at 1/100 shutter speed, the chart shows 110 as the guide number. With a subject at 10 feet from the camera, divide 110 by 10, which equals 11. Set the aperture at f:11.

FLASHBULB ▶		Sylvania SF (Use X Setting)		Sylvania Bantam 8 (Use M Setting)			Sylvania Press 25 (Use M Setting)			
		Up to 1/50	1/100*	Up to 1/50	1/100	1/300	Up to 1/50	1/100	1/300	
COLOR FILMS	Ektachrome Type F Ansochrome Flash Type	55**	55**	80	70	50	130	110	75	
	Ektachrome Daylight Ansochrome Daylight	Blue lamps (Press 25B) required with Daylight Color Film						95	80	50
	Kodachrome Daylight	Blue lamps (Press 25B) required with Daylight Color Film						52	44	28
	Kodachrome Type F	45**	45**	65	50	35	100	75	55	
	Kodachrome Type A	55	55	60***	45***	30***	80***	60***	45***	
BLACK & WHITE FILMS	Kodak Panatomic-X	65	65	75	60	40	125	100	70	
	Anso Supreme	80	80	95	75	50	160	125	90	
	Kodak Plus-X	115	115	135	105	75	230	175	110	
	Anso Ultra Speed Pan	115	115	135	105	75	230	175	110	
	Kodak Tri-X	160	160	205	180	150	320	250	170	

*The five-millisecond delay, characteristic of gas-filled lamps, prevents adequate exposure at shutter speeds faster than 1/100 second.

**SF lamps require 82B type correction filter.

***Wire-filled bulbs require 81C type correction filter with this film.

(For ELECTRONIC FLASH UNITS, use "X" setting and consult manufacturer's exposure instructions.)

interchangeable lenses

Instantly interchangeable Argus Cintagon lenses provide the right focal length for every picture and let you take full advantage of the versatility built into your C44 camera. With Argus C44 35 mm Wide Angle and 100 mm Telephoto Lenses added to your camera kit, you won't miss a single photographic opportunity!

The standard 50 mm lens and both accessory lenses are hard coated and color-corrected, assuring you professionally sharp black-and-white negatives and brilliant color slides. These precision Cintagon lenses feature a rigid bayonet-type mount like those of the world's most expensive cameras, enabling you to interchange them quickly and easily.

Easy-to-read depth-of-field scales, "click-stop" aperture settings, and the Argus Color-matic system of "universal" settings for simplified picture-taking are some of the other advanced features of these specially designed lenses. Built-in lens hoods keep the direct rays of the sun from striking the lens and also serve as retaining rings to hold filters and supplementary close-up lenses.



50 mm Standard Lens

This fast, four element Cintagon lens is capable of handling a wide variety of picture-taking situations. Its large maximum aperture of f:2.8 allows you to take pictures even under very low light conditions. This "fast" lens and "high speed" films make photography indoors by existing light a real possibility.



35 mm Wide Angle Lens

Very useful for snapshot work because of its extremely great depth of field, this f:4.5 Cintagon lens covers 87% more area than the standard lens. It lets you include more scenery in your vacation slides and is just the thing where there is little room to step back from your subject.

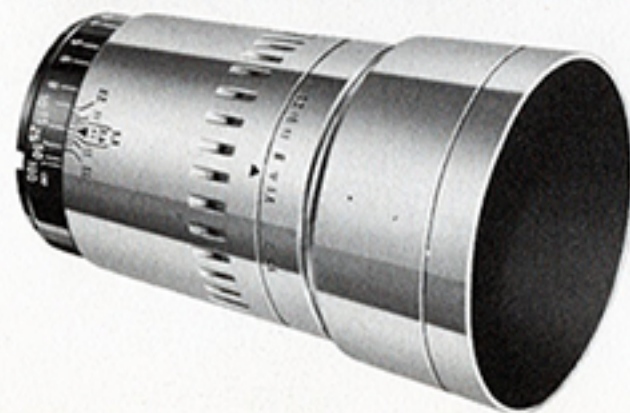

100 mm Telephoto Lens

This f:3.5 Cintagon lens reaches out . . . bringing your subject twice as close. Its 100 mm focal length makes candid shots easier and permits "close-ups" without standing close! Because it provides enlarged pictures of distant subjects, you'll use it to shoot far-away scenery, animals, and sports events.

Interchangeable lenses, cont.

The ease with which the Argus C44 lenses are interchanged will amaze you. A push of a button and a twist of the wrist remove the lens . . . the simple alignment of red dots, insertion of lens, and another twist of the wrist locks the lens securely in place. It's automatically coupled to the rangefinder.

To protect the delicate mechanism of the shutter, **NEVER LEAVE CAMERA WITHOUT A LENS OR COVER ON IT.** Also avoid changing lenses in bright sunlight. When the accessory lenses are not being used, they should be stored in their leather carrying cases.

TO INSERT FILTER, grasp diaphragm control ring, unscrew lens hood, drop filter in front of lens, and screw on lens hood again. Both Wide Angle and Telephoto Lenses accept Series VI (1 5/8" diameter) filters and supplementary close-up lenses.



REMOVAL

Turn rangefinder dial so that **THE DISTANCE SCALE IS SET AT INFINITY (∞).** Hold camera in left hand so that *rangefinder dial and body lens mount are free to turn during uncoupling operation.* Hold lens barrel with right hand. While right thumb is pushing up on lens lock release, give lens barrel a quarter-turn to the left (counter-clockwise) and lift lens out.



INSTALLATION

To prepare the body lens mount to receive any of the three lenses, turn the rangefinder dial to bring the red dots in the mount opposite each other. Then prepare the lens barrel for installation by turning the black distance scale to infinity (∞), aligning the two red dots in the base of the lens barrel. (See illustration).



Insert lens barrel carefully into the body lens mount, fitting the notch on the black ring over the square projection in the body lens mount. When the lens is fully seated, turn it to the right (clockwise) **AS FAR AS IT WILL GO,** about a quarter-turn. Allow rangefinder dial and body lens mount to turn freely. Lens locks securely in place, automatically coupled to the rangefinder.

argus variable power viewfinder

The precision optical system of the new Argus Variable Power Viewfinder gives you a choice of three magnifications of the field of view, corresponding with the areas "seen" by your 35mm Wide Angle, 50mm Standard, and 100mm Telephoto Lenses. A built-in parallax adjustment compensates for differences that would otherwise occur between the fields of view of the lenses and viewfinder . . . it tilts the lens system within the viewfinder so that you see precisely what your lens sees at any distance.

To mount the viewfinder on your C44, slide its mounting foot into the camera's accessory shoe. Focus through the built-in rangefinder-viewfinder of the camera.

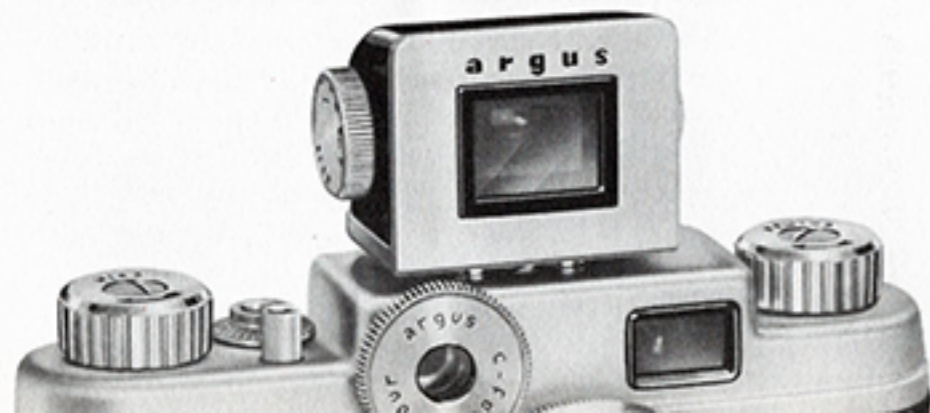

with the 50mm Standard Lens . . . Set the small dial on the left side of the unit so that the "focal length" number "50" is opposite the white dot. The larger dial on the right side is for parallax correction. Set it at the distance indicated on the distance scale after the camera has been focused.

with the 35mm Wide Angle Lens . . . Set the small dial to "35" and the larger dial to the distance you are from your subject. The infinity setting (∞) is used for distant subjects . . . when your subject is closer than 15 feet, set the correct foot-number opposite the white dot.

with the 100mm Telephoto Lens . . . Set the dial to "100" and adjust the parallax-correction dial. The illustrations at left show you how your subject will look through the Argus Variable Power Viewfinder—not masked down, but magnified to the full proportions of the viewfinder.

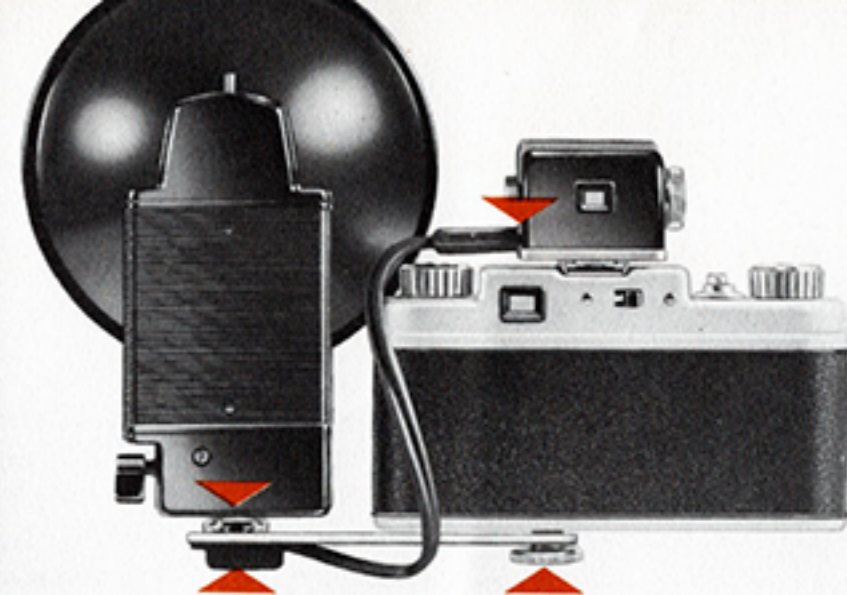

TO TAKE FLASH PICTURES WHEN THE VARIABLE POWER VIEWFINDER IS USED, mount flash unit on the C44 Flash Extension Bracket. The bracket is held in place by the C44 case screw or by a tripod screw. To attach bracket, loosen screw on bottom of leather case and slide camera part-way out. Slip bracket into slot in end of case, and place hole in bracket over end of safety screw. Slide camera back down onto screw, and tighten. Mount flash unit on camera, and plug cord into socket in Variable Power Viewfinder. To use Flash Extension Bracket on the C44 without using leather case, case screw may be removed to hold bracket on camera, as illustrated.

specifications

PICTURE SIZE: 1" x 1 $\frac{1}{16}$ " transparencies in 2" x 2" mounts; or 3 $\frac{1}{4}$ " x 4 $\frac{1}{2}$ " standard black and white prints.

FILM SIZE: 35mm, roll cartridge.

LENS: 50mm (2") Argus Cintagon f:2.8 color-corrected, coated anastigmat; diaphragm openings from f:22; rangefinder-coupled automatic focusing, 3 ft. to infinity; hyperfocal distance: 57' 8" at f:2.8; field covered: 27° x 40° angular at infinity; resolving power: 120 lines per millimeter at center of field. Bayonet-type mount; depth-of-field scale on lens barrel.

SHUTTER: Behind lens type; gear-controlled speeds at 1/10, 1/25, 1/50, 1/100, 1/300 plus bulb (B); body release, threaded for ASA cable; automatically cocked with film wind action; synchronized for "M" (20 millisecond delay) and "X" (zero delay) flash equipment, including electronic flash units.

FLASH: Lock-on type, fits accessory shoe on camera and accessory mounting bracket; synchronized through mounting contacts; auxiliary bayonet terminal provided for connection to secondary flash when using B-C power unit; 5" polished reflector with bayonet type socket for all Sylvania midget base flash lamps; push-button lamp ejection.

LENS ACCESSORIES: Built-in filter retainer for Series V (1 $\frac{3}{16}$ " diameter) filters and supplementary lenses.

OTHER FEATURES: Die-cast metal body with leather-grain and satin metal trim, 5 $\frac{1}{2}$ " x 3 $\frac{1}{8}$ " x 3 $\frac{1}{4}$ ", weight 26 oz.; automatic exposure counter; Color-matic settings for aperture, shutter speed and distance for average subjects in bright sun; double exposure prevention; tripod socket; leather eveready carrying case with shoulder strap. Accessories include interchangeable lenses and Variable Power Viewfinder.

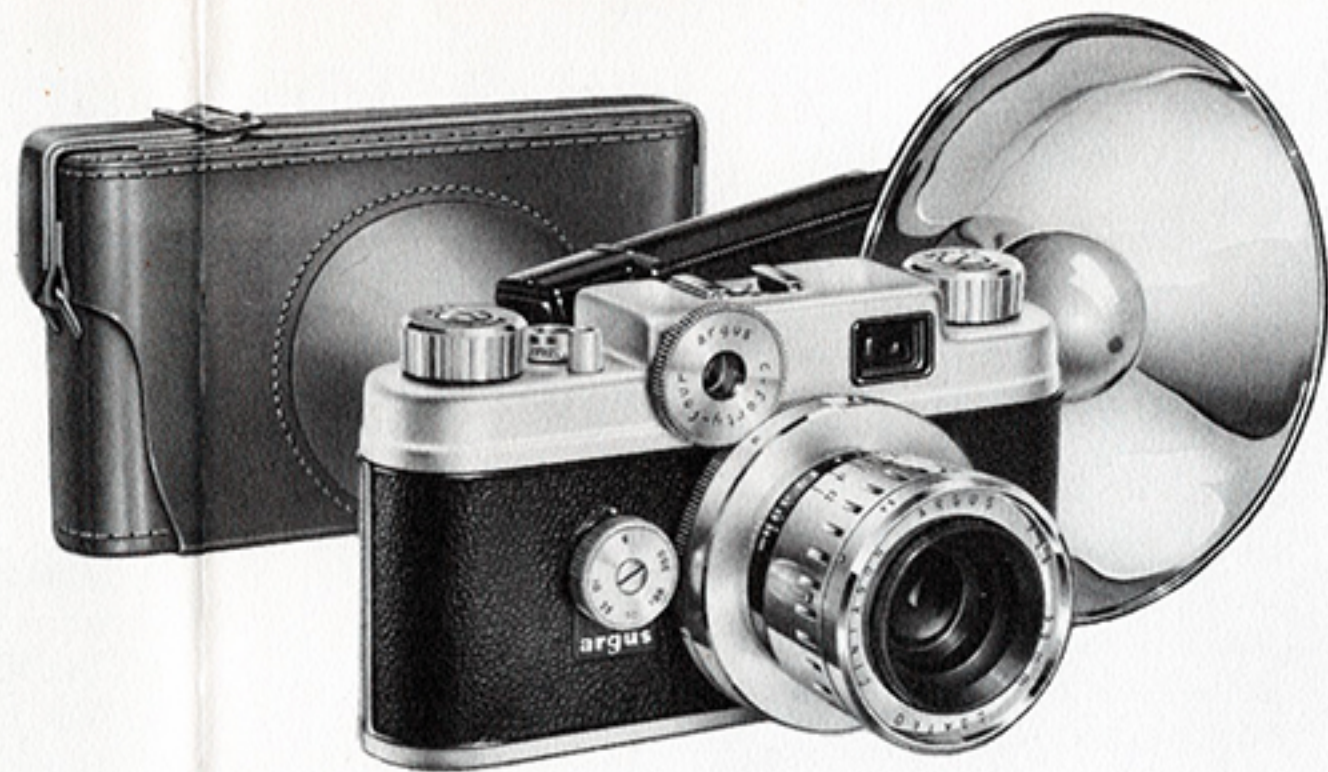

care and cleaning

Your Argus C44 is a precision optical instrument, and with reasonable care and occasional cleaning will operate perfectly for a lifetime. To keep your C44 in perfect working order, protect it from prolonged exposure to sunlight and high temperatures. Don't store the camera in your car's glove compartment, which gets very hot in summer, and try to avoid sudden changes in temperature which result in the formation of condensation on the lens.

The fine lenses of your C44 are ground, polished and coated with extreme precision, and should be handled carefully. If they need cleaning, blow off the dust (or, if necessary, use soft brush with light touch), breathe on lens surface, and wipe gently with lens tissue. Do NOT use alcohol or ordinary cleaning fluids.

For service or replacement parts for the C44 Camera and its accessories, contact your local Argus Dealer or write to: PRODUCT SERVICE DEPT., ARGUS CAMERAS, ANN ARBOR, MICH., OR ARGUS CAMERAS OF CANADA, LTD., TORONTO, ONTARIO.

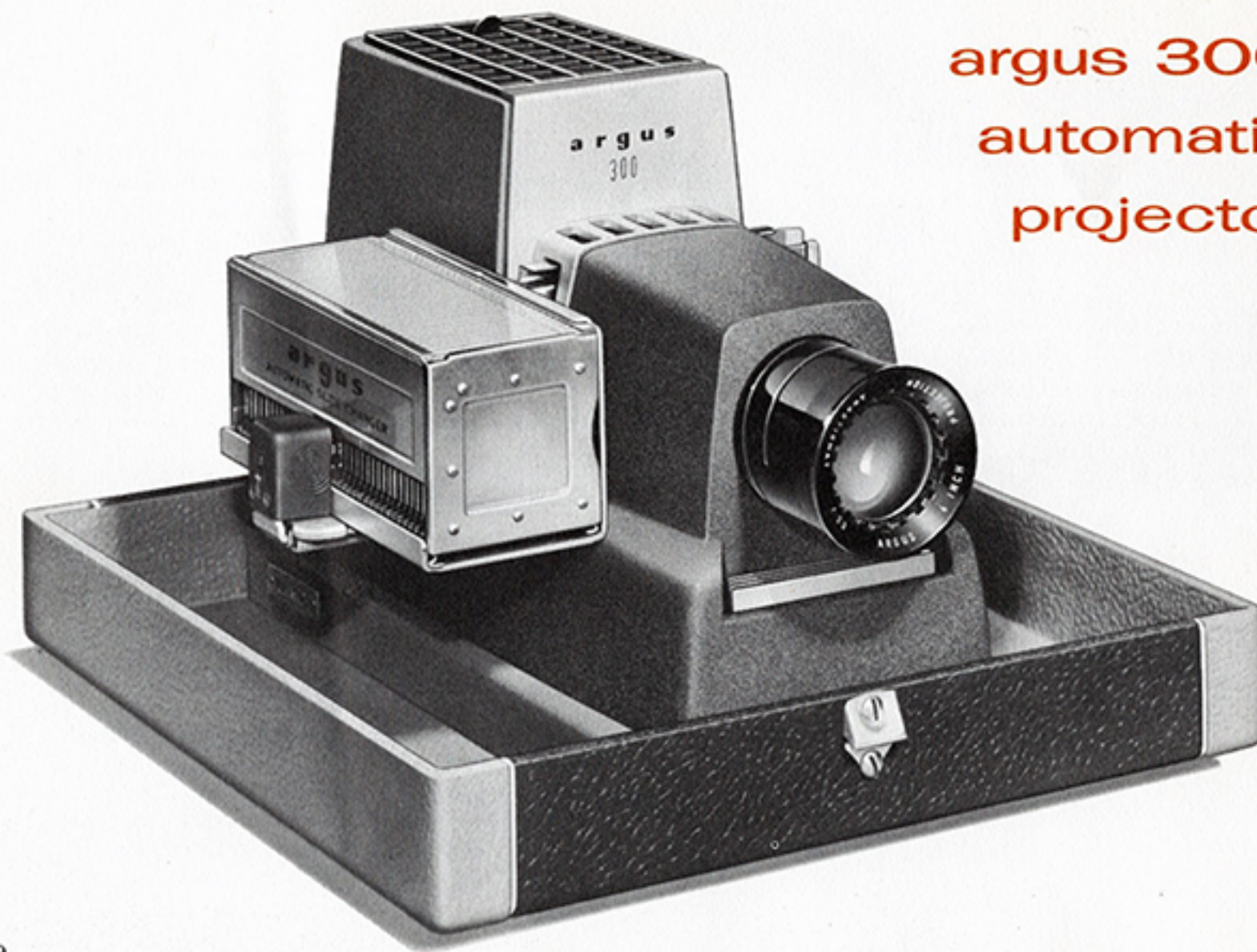

argus 300
automatic
projector

America's newest and finest value in color slide projection equipment. Brilliant 300 watt, blower cooled illumination combines with new 4" Argus f:3.3 projection lens for big, life-like pictures, even in a small room. All metal changer selects, projects, and refills 36 slides automatically—each in its own protective metal frame. Roomy carrying case, with space for extra magazines, and single slide editor included.

Also available with same optics and basic construction in standard model with changer and case as accessories. Argus Remote Control Power Unit available for both models.

argus L44 clip-on meter

A lifetime of "good picture insurance." A perfect companion to your C44—mounts in the accessory shoe atop your camera for "hands-free" exposure guidance in a hurry. Just one touch of the dial relates apertures from f:1.4 to f:22 with a selection of shutter speeds from 120 seconds to 1/1000 second—perfect exposures every time without guesswork or calculations. Incident light adapter and leather case included. Booster Cell for low-light readings available as accessory.

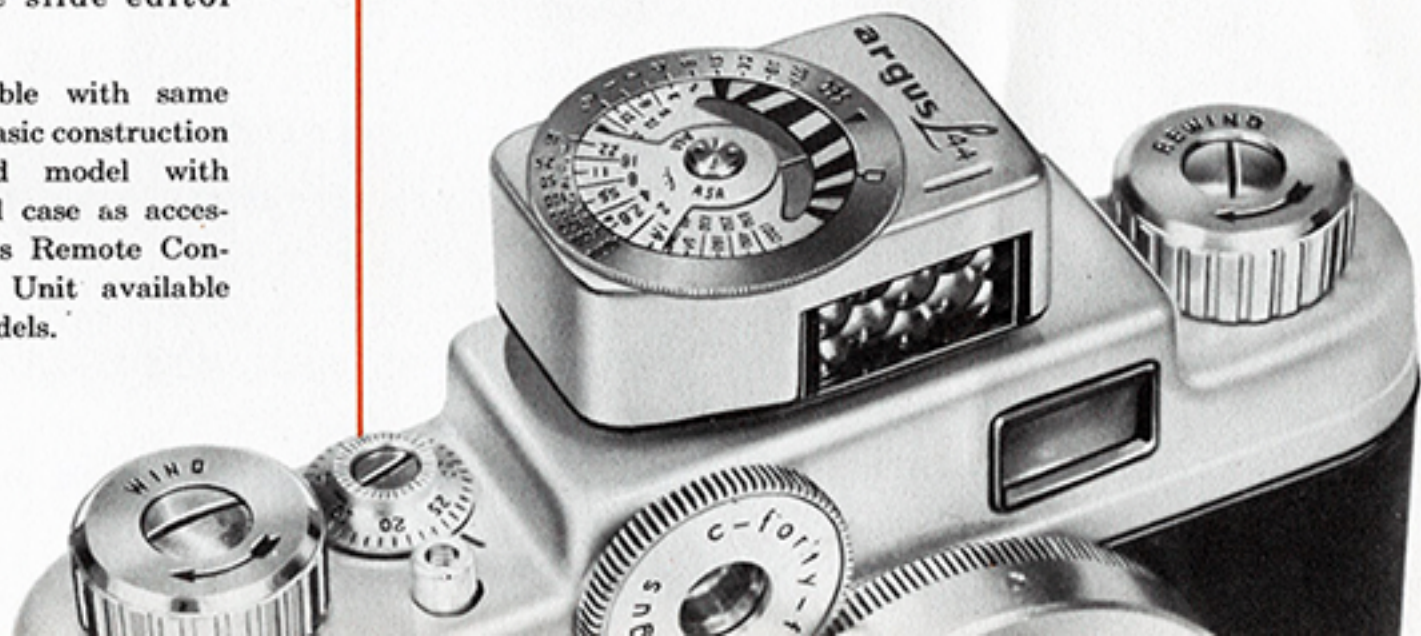

Lifetime guarantee

Your Argus C44 Camera was manufactured, inspected and tested by skilled camera craftsmen. It is automatically guaranteed when purchased to be free of defects in workmanship or material during its lifetime. If any servicing is necessary because of imperfections in materials or workmanship, your camera will be factory serviced without charge.

Argus equipment which has been damaged, mishandled or worn from extended use will be factory serviced at established rates. Used or rebuilt equipment is not covered by this guarantee.

ARGUS CAMERAS, ANN ARBOR, MICHIGAN

Division of Sylvania Electric Products Inc.

ARGUS CAMERAS OF CANADA, LTD., TORONTO, ONTARIO